

- Screw-on
- Press-in
Ø 8 mm
- Speed fixing

With spring

Without spring upon request

SPEED

Opening	A
95°	10.5
110°	11.3
125°	12
170°	11

Code	Overlay table	Door and arm protrusion											
		D = Cup boring distance				95°		110°		125°		170°	
B		3	4	5	6	D.P.	A.P.	D.P.	A.P.	D.P.	A.P.	D.P.	A.P.
4.5	B0780ZG45	15.5	16.5	17.5	18.5	9	18.2	8.8	18.2	9.5	20	4.7	55
8.0	B0780ZG80	12	13	14	15	12.5	21.7	12.3	21.7	13	23.5	8.2	58.5

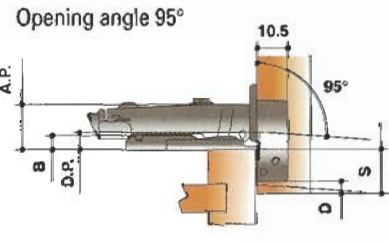
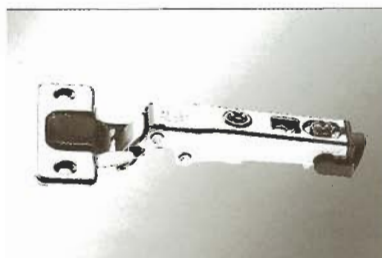
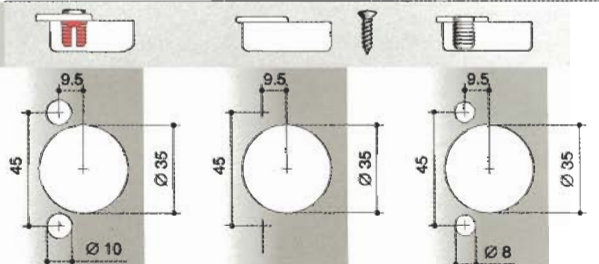

H90418A**	H90078A**	H90080A**

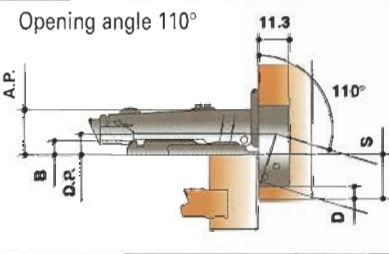
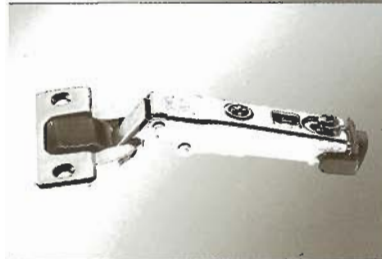

H90419A**	H90079A**	H90081A**

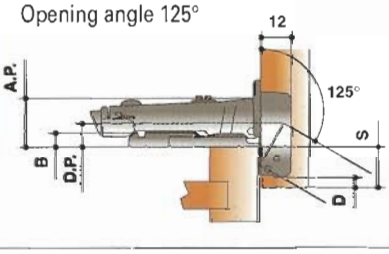
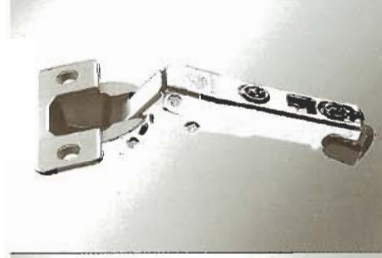

C90426A**	C90012A**	C90016A**

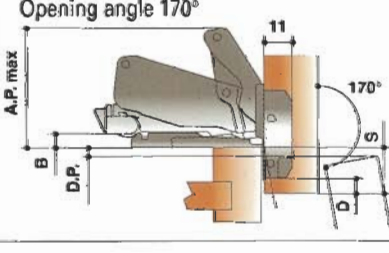

C90422A**	C90300A**	C90301A**
	A = Full overlay	
	C90301C available	
	C = inset	

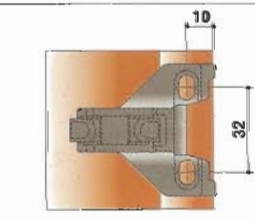

B = 4.5	B0780Z*45
B = 8.0	B0780Z*80

Subject to technical modifications without notice

Anyway Clip 90

Clip hinges with adapter mounting plate

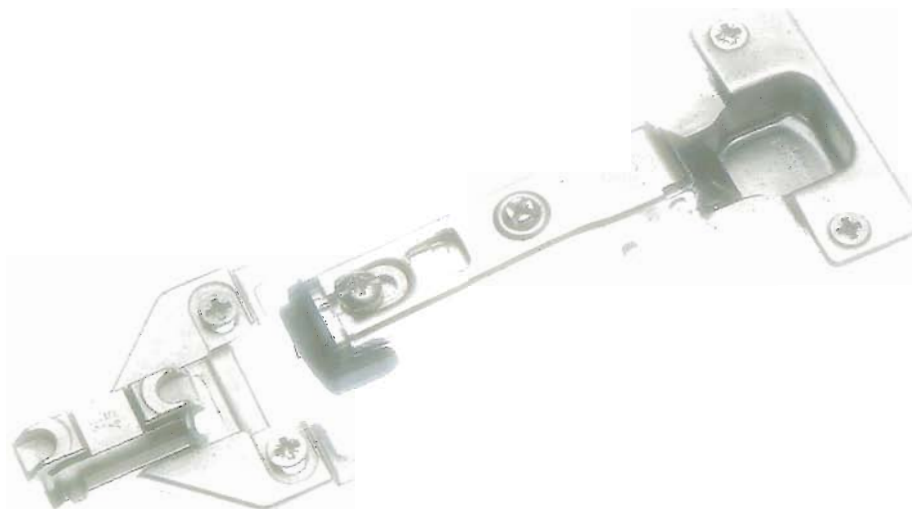

24

- Anyway Clip 90 hinges series features a particularly easy and secure attachment system connecting the hinge arm and the mounting plate from a variety of angles as opposed to just one, maximum ease in mounting even on large doors where more hinges are required.
- Simply click on the hinge to the plate in any sequence.
- Accidental release is impossible.
- Anyway Clip 90 hinges can be fitted to frame construction cabinets by using a face frame adapter plate made of die cast. The adapter plate is equipped with front tabs aligning the plate on the face frame for correct mounting.
- Copper, Nickel-plated finish, high corrosion resistance.
- Anyway clip 90 features independent adjustment of the door in three directions, including side-to-side automatic adjustment.

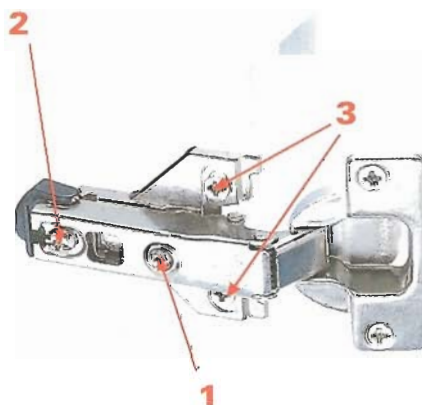

Overlay automatic adjustment:

turn screw No.1 to increase or decrease door overlay (+ 0.5 mm up to - 4 mm).

Vertical adjustment:

loosen screws No. 3, adjust door and tighten screws again (4 mm range).

Front adjustment:

loosen screw No. 2, adjust door to desired position and tighten screw again (3 mm range).